

# C2 Pro

Professional POE Fingerprint & Card Terminal

Quick Guide v1.5

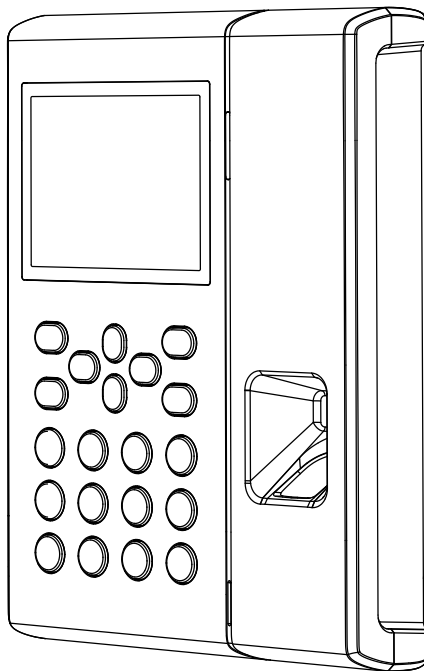

## Getting to Know the C2Pro

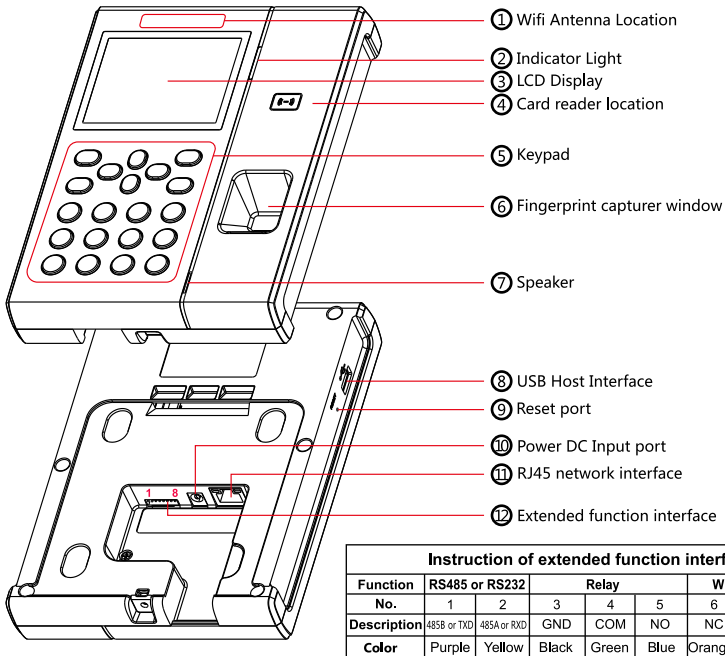

\*Pay attention: Factory default is RS485

Instruction of extended function interface								
Function	RS485 or RS232		Relay		Wiegand Output			
No.	1	2	3	4	5	6	7	8
<b>Description</b>	485B or TXD	485A or RXD	GND	COM	NO	NC	WO1	WO0
<b>Color</b>	Purple	Yellow	Black	Green	Blue	Orange	White	Green

## C2Pro Features

- \* Standard 3,5-inch Industrial TFT LCD
- \* Dual-core 1GHz processor, Linux operating system
- \* Optical fingerprint scanner, wear-resistant, long life
- \* Multi-identification: Fingerprint, Card, ID + fingerprint, ID + Password, Card + fingerprint and Card + Password
- \* Support Low-frequency card : HID Proximity, EM Card And other compatible card(125kHz)
- \* High-frequency card: Mifare, HID iClass, aptiQ Such as compliance with ISO14443 protocol card
- \* Customers can customize a variety of voice and attendance status, support message and multimedia video
- \* Support TCP/IP, RS232 or RS485, Wiegand Output , USB Host and Wifi communication
- \* Can be connected with the SC011 access controller system to achieve split security
- \* Support real-time record downloading, online monitoring, remote server access control or high-end features such as Time Attendance
- \* Registration capacity: 5000 Fingerprints and 100000 Records
- \*Power Over Ethernet provide device network communication and the power is enough for device

# Installation Guide

## 1. What's in the package?

### 1 Device

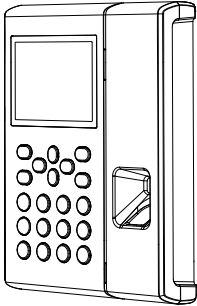

\*Card is optional

### 2 Instruction Package

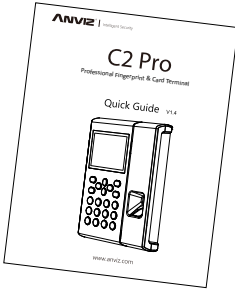

### 3 Accessory Package

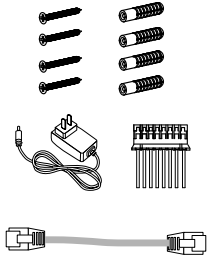

## 2. Mount the C2Pro to Wall

- \* Install the mounting panel on the wall
- \* Plug in the charger and Ethernet cable
- \* Slide the C2Pro down onto the panel and secure with the screw on the bottom of C2Pro

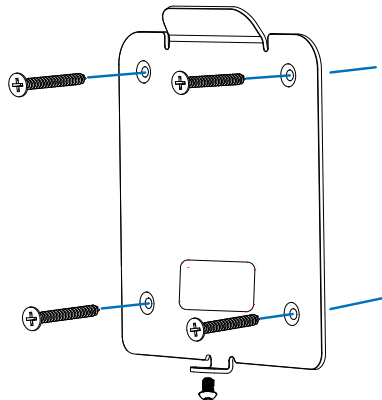
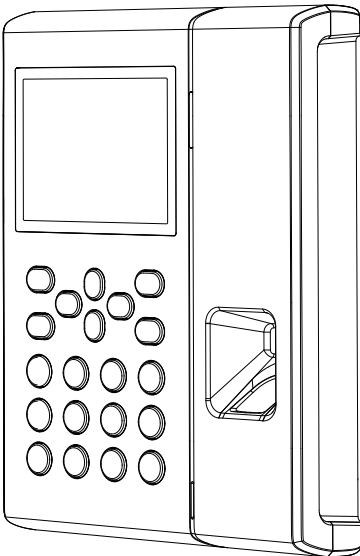

# Basic Operation

## 1. Turn on the C2Pro



Plug in the power supply and wait for the C2Pro boot up.



Press [M] key to go to Admin menu. Input "0" as ID and "12345" as password to log in.

\* 0/12345 is the default Admin ID and password. You can change to your own the password or set other user as Admin later.



Browse the Setting \ Device menu to view or edit the Device ID and Admin PIN Code.

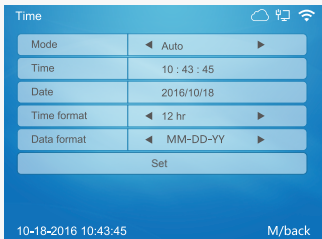

Go to Setting \ Time menu to set up date and time.

## 2. Add Users to C2Pro

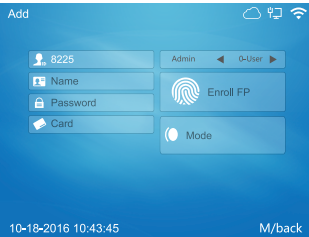

Go to User \ Add menu. Follow the menu to input ID, name and password. Move the cursor to "Enroll FP" section and click [OK] key.



Scan the same finger twice to enroll the fingerprint.

\* RFID Card is the optional feature. If you have the card option and want to enroll the card, use the up & down key to move the cursor to card number field. Swipe the card on the face of right side of C2Pro. The card number will be displayed.

### 3. Input Characters

When you edit name or WiFi password, you may need to input characters. Here are the steps to input characters:

- \* Using the up and down arrow key to move the cursor to the field.
- \* Press [Fn] key on the keypad, a character input window "Aa" will be displayed on the bottom of the screen. Then press the number/letter key. A second window will appear and you can select the letter by number key .
- \* Press [IN] key on the keypad, the character input window will toggled between "Aa", "123", ".!?" and "拼". You can select the window to input the letter, number or special symbols.

### 4. Verity the Fingerprint

#### ■ Correct method :

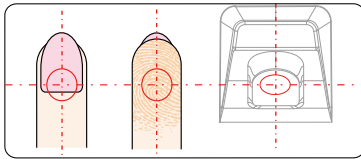

Place finger in the center of the sensor.

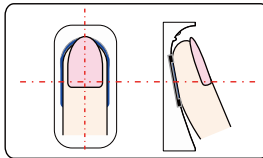

Place finger flatly and smoothly on the sensor.

#### ■ Incorrect method :

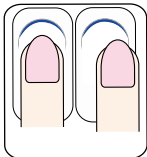

Finger not placed on the center of the sensor



Finger placed inclined

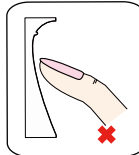

Use of fingertip

#### **Note:**

1. It is better for each user to register two finger prints in case of one finger can't work.
2. Place finger flat and make sure the center of the finger is on the center of scanner window and press a little hard on scanner, so it can scan as large finger area as possible to extract enough minutia.
3. Keep the angle and direction of finger the same each time placing on scanner.
4. If your finger has sweat or water, please dry it first and then register the finger.
5. If your finger is too dry, make it a little wet or touch the forehead to increase the wetness of the finger, press a little hard on scanner. (The dry finger can cause the finger image not coming out clear enough.)
6. Avoid the callus, peeling, or injury of the finger to ensure the register and identification successful.
7. You can register the thumb first, and then index finger or middle finger to increase the precision.

### 5. Setup the C2Pro Communication

- \* Go to Network \ Internet menu to select Ethernet or WiFi
- \* Go to Network \ Communication Mode to select Server or Client mode
- \* Go to Network menu to setup Ethernet or Wifi parameter according to your network settings
- \* Ping the IP address of C2Pro from the management computer. Make sure the Ping is successful

## 5.1 Ethernet Settings

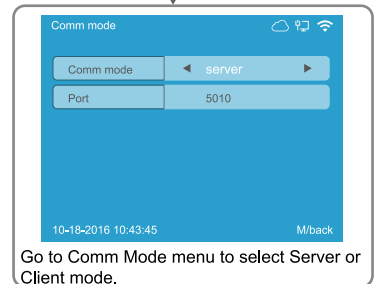
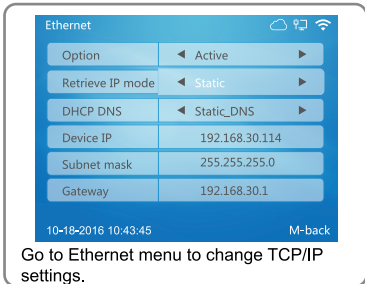
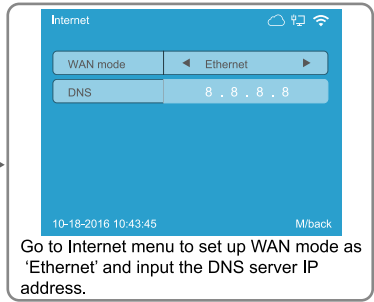

## 5.2 WiFi Settings

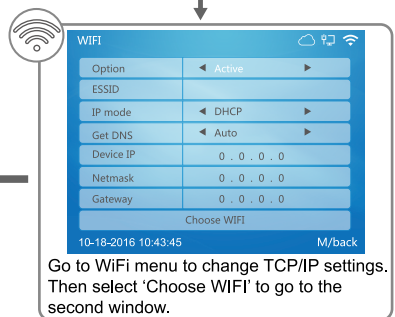
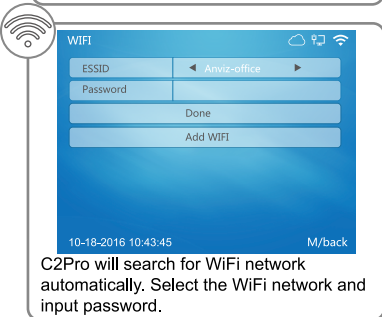
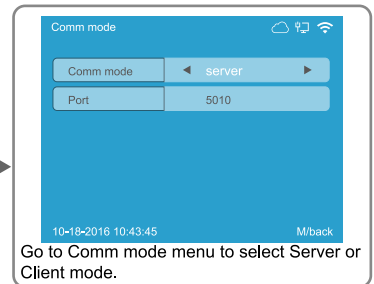
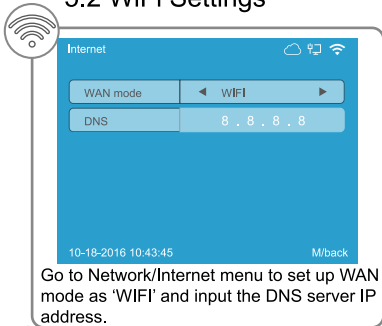

# Working with Management Software

## 1. Install the Management Software on Computer

Put the CD in the management computer. The installation program will run automatically.

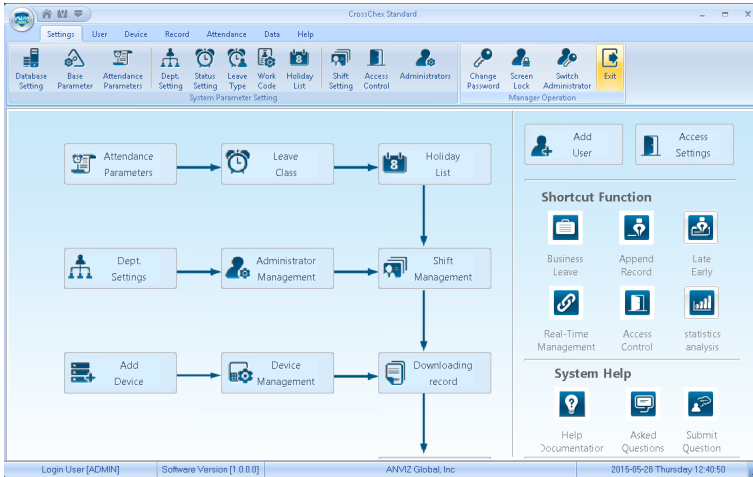

## 2. Enable Communication between C2Pro and the Management Software CrossChex

- \* Turn on management software CrossChex
- \* Go to Device tab. Search and Add the C2Pro to management software CrossChex
- \* Click Synchronize Time button to communicate with C2Pro. If Synchronize is successful, the device icon will turn to blue

## 3. The Management Software CrossChex Features

- \* Device \ Backup User: Download user info from C2Pro to CrossChex
- \* Device \ Download Records: Download records from C2Pro to CrossChex
- \* User \ Modify: Edit name or other user info. Then click "Upload User" to Upload user info to C2Pro device
- \* Record \ Search: Search and view the records
- \* Attendance: Calculate, Search results and Generate reports
- \* Data \ Backup Database: Backup Database
- \* Setting \ Shift: Set up Time Table and Scheduling
- \* Device \ Device Parameter: Set up device, Clear records on C2Pro or Reset C2Pro to factory settings

# Connect C2Pro to your Network

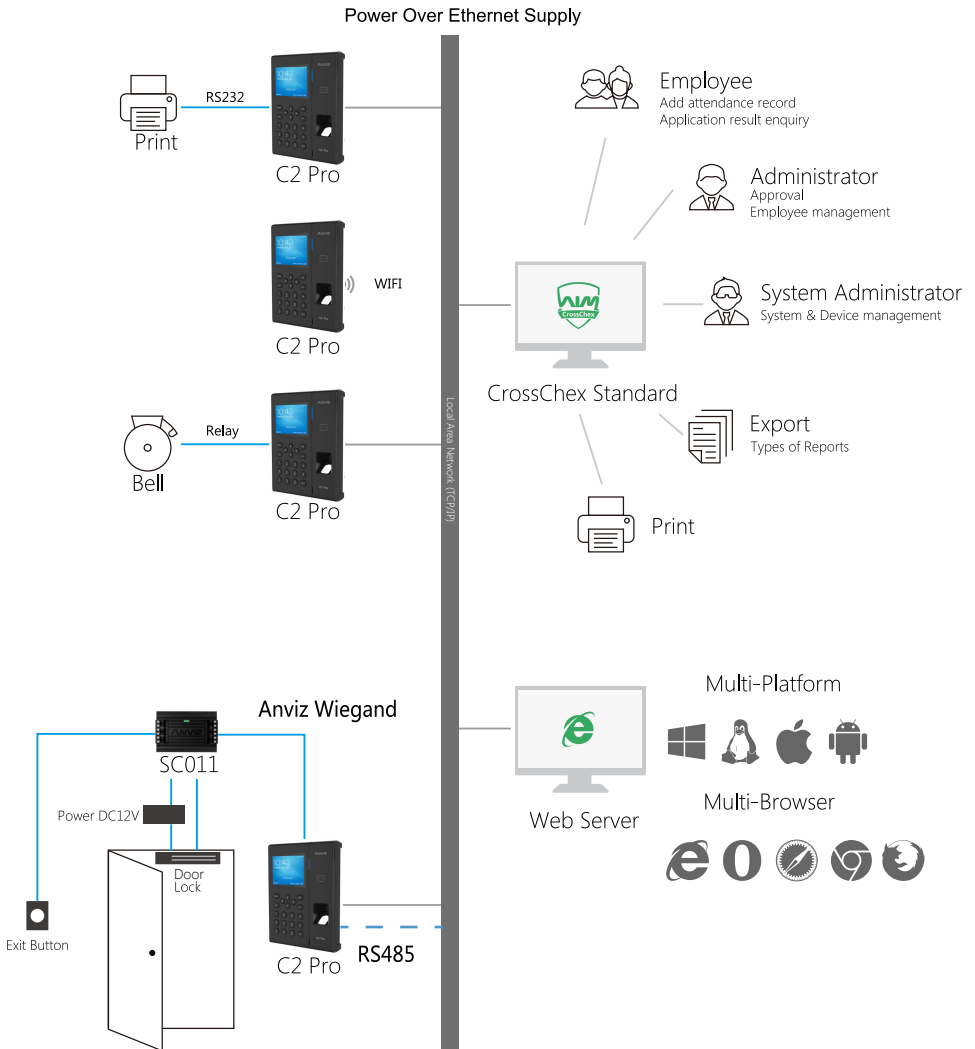

Have a question? Please feel free to send emails to [support@anziv.com](mailto:support@anziv.com) to get support.