

ANVIZ®

POWERING A SMARTER WORLD

FaceDeep 5

AI Based Smart Face Recognition Terminal
Quick Guide V2.0

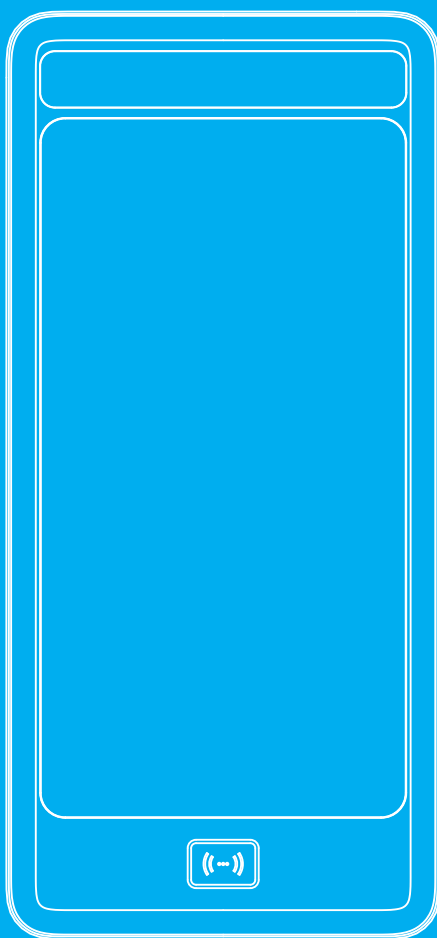

Anviz brand and product are trademarked and protected under law of the United States.
Unauthorized use is prohibited.

For more information visit www.anviz.com, or email marketing@anviz.com for further help.

©2020 Anviz Global Inc. All Rights Reserved.

! Notice

- Do not use oily water or sharp objects to stain or damage the display screen.
- Fragile parts are used in the equipment, so please avoid operations such as falling, crashing, bending or heavily pressing.
- The normal working environment of the display screen and key parts of this equipment is indoor environment. Beyond this temperature range, the equipment will be less effective with reduced functionality and performance. Operating temperature: -30°C~60°C, Operating humidity: 20-90%.
- Please gently wipe the screen and panel with material of soft cloth. Avoid scrubbing with water or detergent.
- The Face Deep terminal recommended power is DC 12V ~ 3A; When arrange the wires, if the 12V power supply cable is in long distance, resulting in large resistance, then the insufficient voltage ($\leq 11V$), The device will be repeat restart, system crash and so on.
- When the ambient light change to dark, the Face Deep 5 has filling light itself.

Parts List

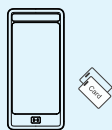

Terminal



Mounting Bracket



Quick Guide



Accessories

Appearance Description

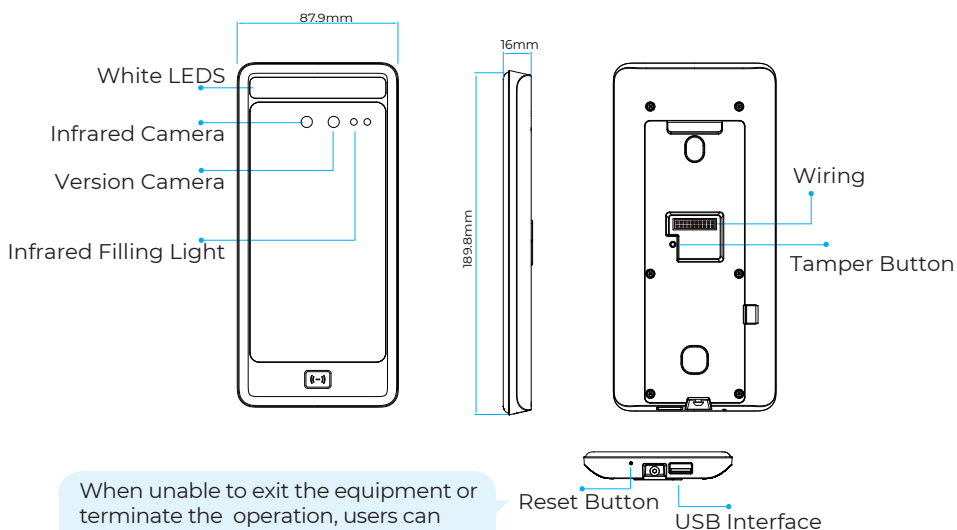

Installation

The Sunlight and Hard Light may lead to big differences between site image and registered image; backlight, side-light and strong light will influence the recognition experience. (Analysis: from the view of human eyes, the color changes on face skin may result in wrong recognition of identity; unclear exposure area, no matter large or small, may influence the identity judgement.)



Side Light



Strong Light



Back Light

Device shall be installed in places avoiding backlight, side-light and strong light.

 The recommended place for Installation (Please keep 3m away from the window, or does not influenced by sunlight, can be considered for installation)

 Backlight, side-light or direct strong light, not suitable for installation.

 Other areas, install in suitable places according to actual light impact.

 Hard Light  Door  Wall

 Curtain  Glass Window or Class Wall

Sunlight Shines Indoor

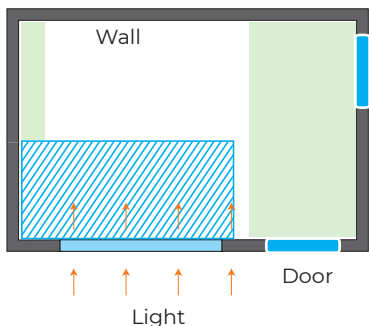

Glass Window

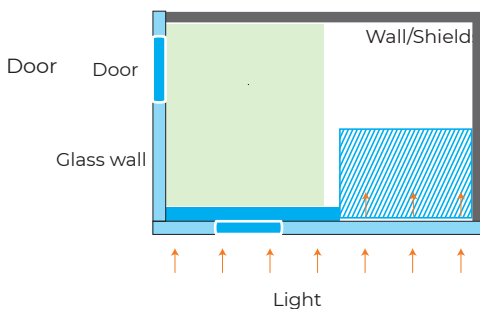

Sunlight Shines Through the Door, with Glass Window at One Side

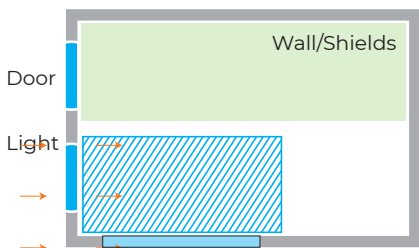

Sunlight Shines Through the Door

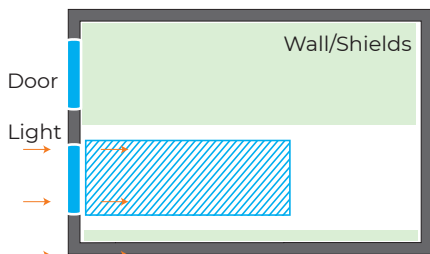

Height

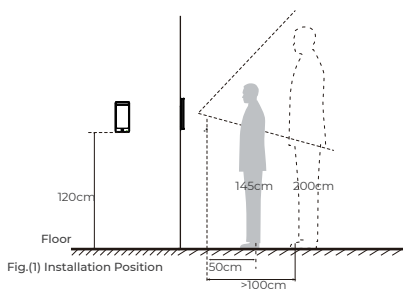

Suggested installation height (the distance between the lens and the ground) is 1.4m, as the recognizable body height range, 0.5m distance away from the device, is 1.3m-1.7m; the recognizable body height range, 1m distance away from the device, is 1m-2m. (There are some deviations)

Steps

- 1 Keep the mounting bracket parallel with the ground and 1.2m distance to the ground. Drill 2 screw holes on the wall according to the mounting bracket ,

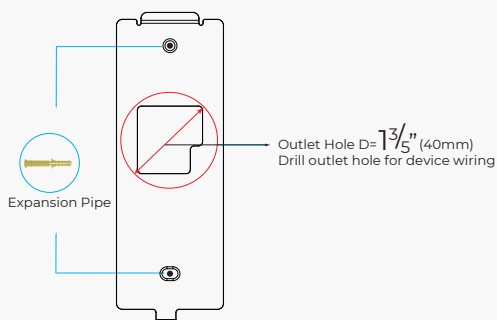

- 2 Please punch out the tail lines from the outlet hole before installing the mounting bracket and use the screws to fix the mounting bracket on the wall. Use the screwdriver to tighten the screw follow the direction indicated, to complete the installation.

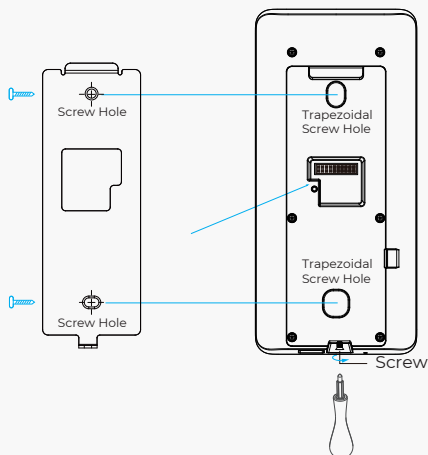

Access Control Power Supply

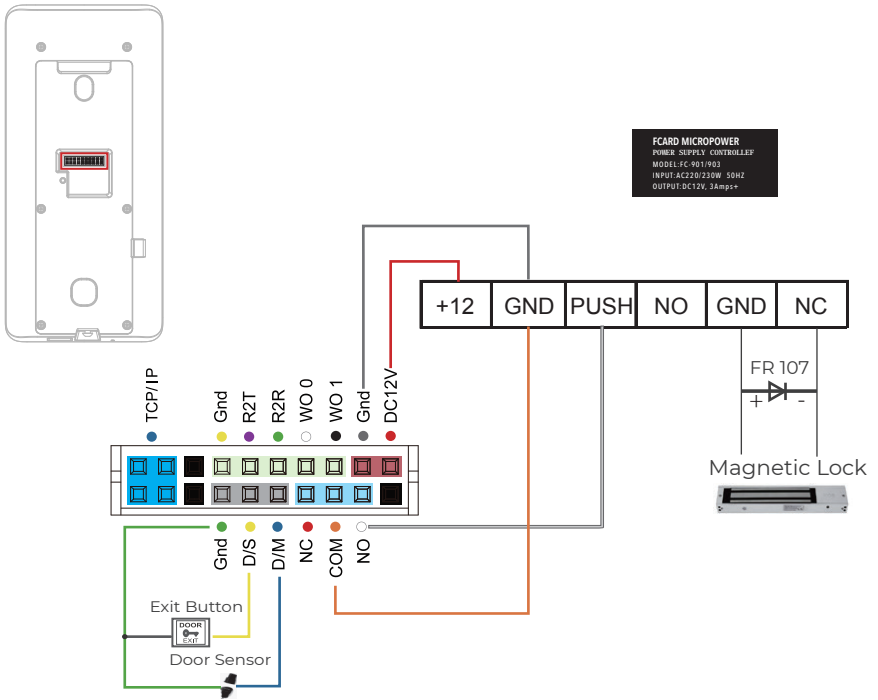

Wiring Connection

SC021 and the FaceDeep5 device are authorized by Anviz wiegand to form a distributed access control system. Please contact sales@anziv.com for more information.

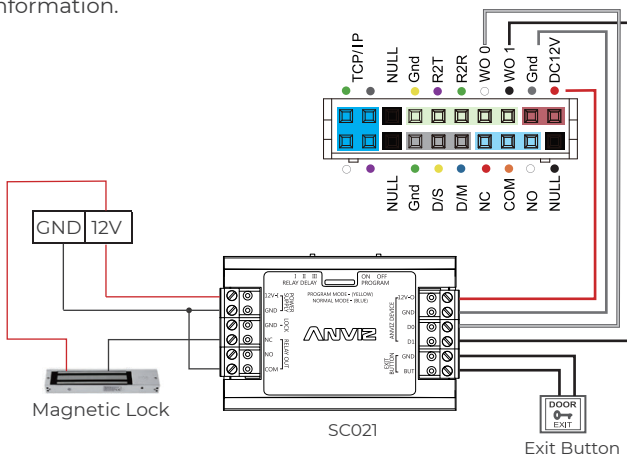

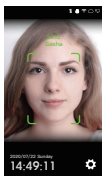

Quick Guide

General Settings



①

Power on the FaceDeep 5 and wait for the activation. Click , then enter admin ID and password to access the main menu. Click , then input employee ID and password to verify.

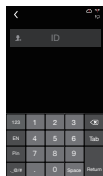

②

Click , then input default ID "0", password "12345" to enter main menu. You can change the admin password according to your needs, or set other users as administrators.

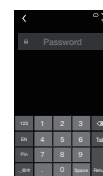

③

Enter system settings \ time to set date and time.



④

Check or edit device ID and admin password in system settings/device.



User Enroll

Quick Face Registration

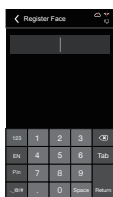

①

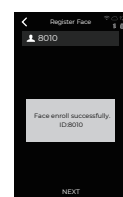
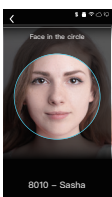

②

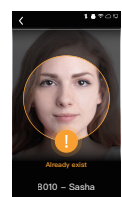

Click "Enroll Face" and input ID for quick face registration.

- Keep face in the center of the detection frame, according to the device request.
- Slightly move head left and right, up and down during the registration.
- If the registration process takes too long or fails, please change the registration position.
- In some cases, the detection frame might move to the top, it might be triggered by glasses. Take the glasses off, and try one again.

Registration of Other Authentication Methods

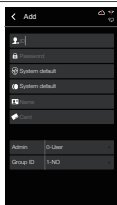

①

① Click "User"/"Add" to input ID, Password and Name. Click "Register Face" to enroll.

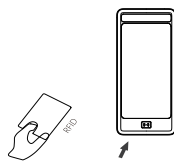

②

Click "Card" and swipe the card at the card detection area to finish the registration.



TIPS

Do not cover the forehead and keep facial area that belows the eyebros visible during the face registration. In order to improve comparison accuracy, users need to attempt multiple possible angles. Be careful not to change the facial expression (smiling face, drawn face, wink, etc.).

Communication Settings

①

Click "Network" option to enter network setting page, then select Ethernet or Wi-Fi

②

Click "Network\Comm Mode" to select server or client mode.

③

Set Ethernet or WiFi parameters based on your network environment.

④

PING FaceDeep 5 IP address on a management computer to make sure the device is connected.

Ethernet Setting



①

Click "Network" option to enter network setting page.

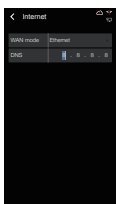

②

Click "Internet" to set WAN mode as Ethernet, and then set DNS IP address.

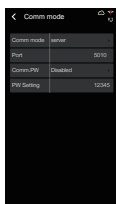

③

Click "Comm Mode" to select server or client mode.



④

Click "Ethernet" to modify TCP/IP settings.

Wi-Fi Setting



①

Click "Internet" to set WAN mode as Wi-Fi, and then set DNS IP address.



②

Click "Comm Mode" to select server or client mode.



③

Click "Wi-Fi" to modify the TCP/IP settings. Click "Choose Wi-Fi" to move to the next steps.

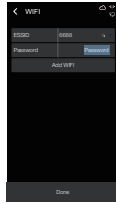

④

will automatically search all available Wi-Fi. Select one to finish the connection.

Matching Precision Setting

Three precision levels : Basic/Good/Excellent

Basic: Excellent face comparison speed.

Good: Fast face comparison speed with high secure protection, recommended.

Excellent: Top security precision, recommended using in a high secure properties.

①

Enter from Main menu to Advanced\T&A\Precision

②

Precision levels : Basic/Good/Excellent

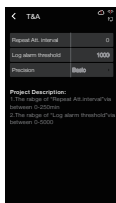

①

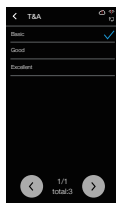

②



In order to protect the environment, Anviz has decided to go "CD Free" campaign since June 1st 2019. We will provide QR code for you to download the electronic documents to make sure that you understand how to install and use Anviz devices.



<https://bit.ly/2WugbYp>

Dropbox



<https://bit.ly/2Vn0wh6>

Google



<https://bit.ly/2J9qA95>

Anviz

Anviz brand and product are trademarked and protected under law of the United States.
Unauthorized use is prohibited.

For more information, please visit www.anviz.com, or send email to sales@anviz.com for more help.

©2020Anviz Global Inc. All Rights Reserved.